

FORI ESAGONALI
M5 DIAM.7,2MM

FORI ESAGONALI
M5 DIAM.7,2MM

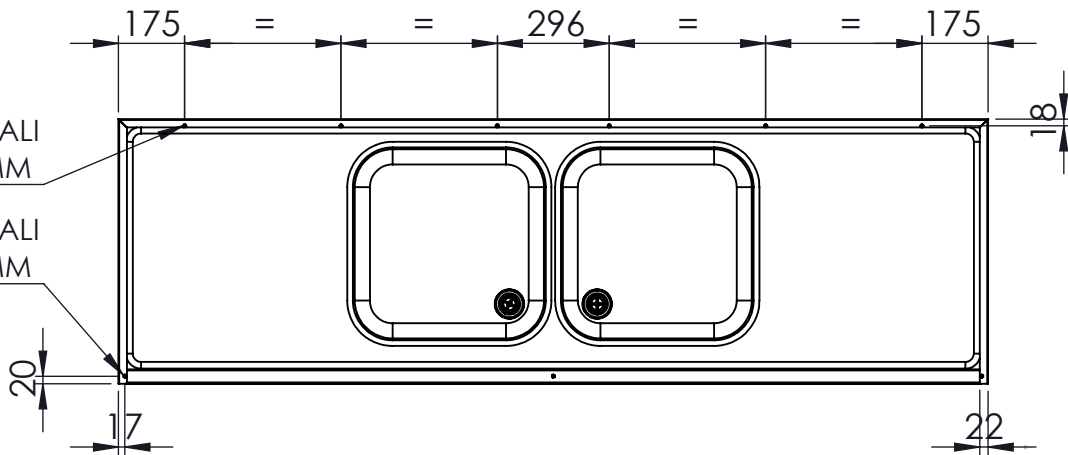

DISEGNATO	
DATA	11/01/2024
PESO	35087.49

CODICE: **M100**



CONFIGURAZIONE: **L:2300 P:700**

SCALA: 1:20

A4

FOGLIO 1 DI 1